

305 Nylon Cable Chain

Inner height (D) 23 mm
Double share single link joining construction with large anti-friction single-pin. Non-opening. Vertical separators are available. Due to its design with double-share lateral side, the chain is very robust, meanwhile offering very low friction. Used with guide channels, this chain is particularly suitable for long distance travel.

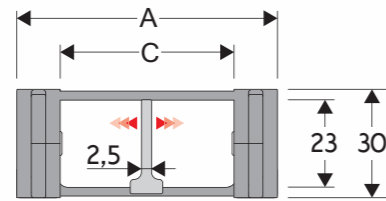

Separator*	
- Unassembled	Part.no S305
- Assembled	Part.no S305MC
Pin	
	Part.no PG305

*Separator not to be used in long-stroke applications

Technical characteristics when self-supported

Speed	10 m/s
Acceleration	50 m/s ²

For higher requirements please consult our technical dept.

A	B	C	D	R	Weight/m	Chain
mm	mm	mm	mm	mm	kg	Part Number
54	30	30	23	50	0,90	305008
54	30	30	23	70	0,90	305010
54	30	30	23	120	0,90	305020
54	30	30	23	150	0,90	305050
74	30	50	23	50	1,00	305009
74	30	50	23	70	1,00	305030
74	30	50	23	120	1,00	305040
74	30	50	23	150	1,00	305060

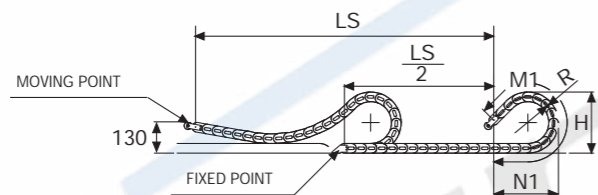
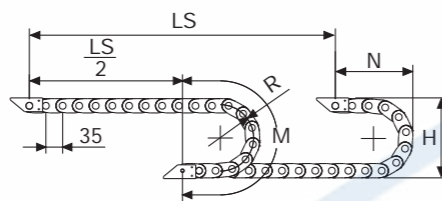

R	H	N	M	N1	M1
mm	mm	mm	mm	mm	mm
50	130	105	230	125	270
70	170	120	290	160	365
120	270	175	450	330	800
150	330	205	545	435	1065

Length of chain (L)
Half travel distance ($\frac{LS}{2}$)
plus length of curve (M) or (M1)

$$L = \frac{LS}{2} + M \text{ or } M1$$

For sliding applications, technical data can slightly change according to frequency, added weight and environment.

SLIDING VERSION to be ordered with pivoting end brackets set

Self-Supporting Capacity Diagram

The maximum length of the self-supporting capacity ($\frac{LS}{2}$) in relationship to the weight of the cables and hoses contained per linear metre.

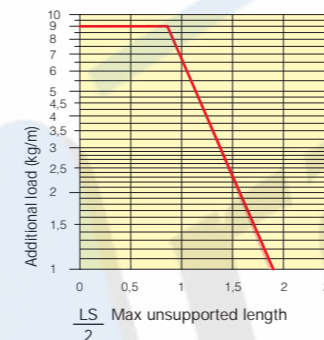

End Brackets

The end brackets set allows the two ends of the chain to be attached to the equipment.

Nylon Type

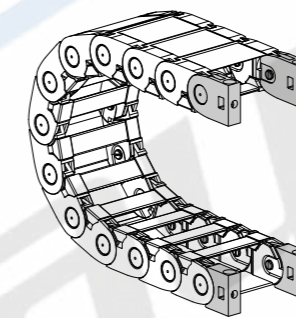

Fig. A The chain can be fixed frontally, inner or outer radius. (Fig A)

Bright Zinc Plated Steel Type***

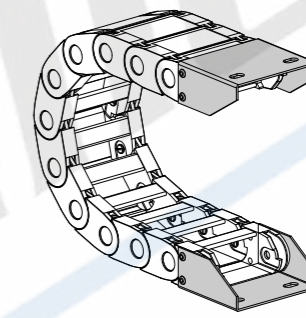
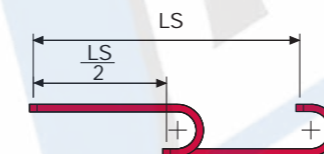
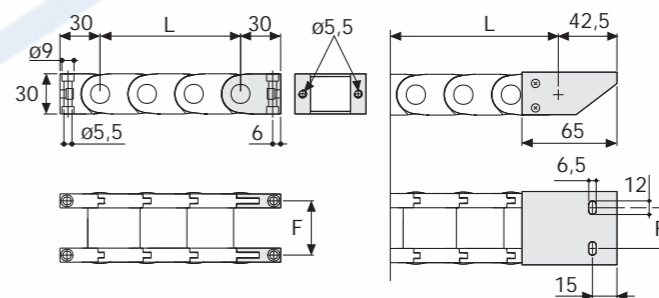

Fig. B Chain fixed outside the radius. (Fig B) See end brackets mounting variations page 31.



The red marking in the diagram area considers the difference of weight between various widths of chain.



For applications with $\frac{LS}{2}$ and weights not included in the area of the diagram showing self-supporting capacity, verify the possible use of support rollers (see page 30).

Chain Type	F mm
305 C=30	40,5
305 C=50	60,5

Chain Type	F mm
305 C=30	30,5
305 C=50	51,5

Nylon Type Part Numbers

Complete Set Assembled Chain Type	End Brackets Set
305 C=30	AN305KM
305 C=50	AN305KM

Complete Set Unassembled Chain Type	End Brackets Set
305 C=30	AN305K
305 C=50	AN305K

Bright Zinc Plated Steel Type Part Numbers

Complete Set Assembled Chain Type	End Brackets Set
305 C=30	AP305KM□**
305 C=50	AG305KM□**

Complete Set Unassembled Chain Type	End Brackets Set
305 C=30	AP305K□**
305 C=50	AG305K□**

** 1=Pos.1; 2=Pos.2; 3=Pos.3
*** Available on request in stainless steel

305 Nylon Cable Chain



Suitable to long travel distance. To choose the guide channel see page 82

Special tool to remove the connecting pivots: Part Number PZ010.



For further information please consult Brevetti Stendalto's Technical Office